



# ALPHA WINDOWS



**Presented by Ramesh Thapa**

# **WELCOME TO ALPHA WINDOWS**

**Established in 2015, Alpha Windows is a reputable manufacturer of premium uPVC doors and windows. Known for durability, energy efficiency, and elegant design, the company serves both residential and commercial clients.**

**With advanced technology, strict quality standards, and eco-friendly practices, Alpha Windows consistently delivers reliable products and Extraordinary customer satisfaction.**

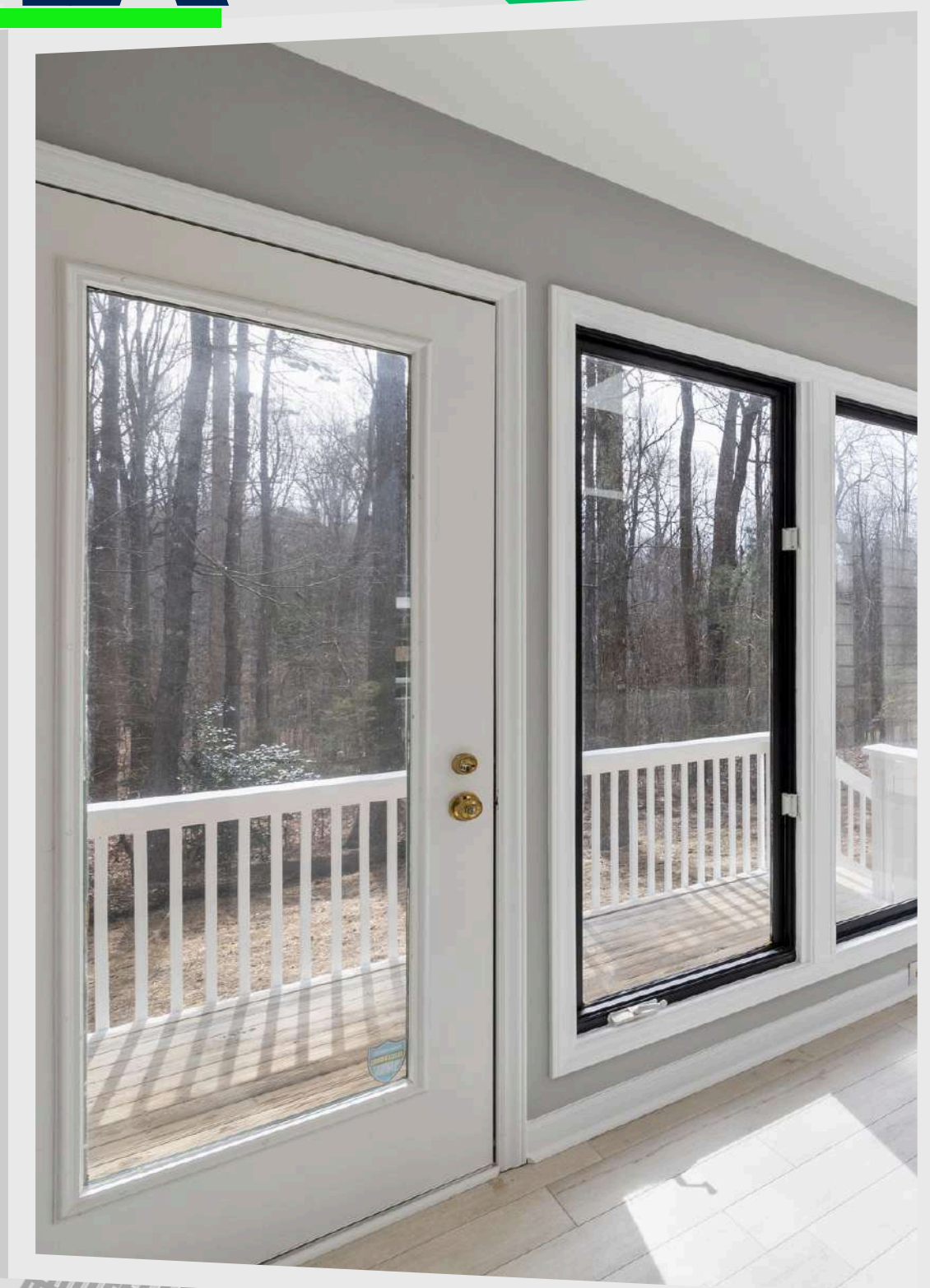

# **WHAT IS UPVC?**

- **uPVC stands for Unplasticized Polyvinyl Chloride.**
- **It's a type of plastic material that's widely used for windows, doors, and other building materials.**
- **Energy efficient, high durability and Low Maintenance. Upgrade to uPVC, Upgrade to Style and Comfort**

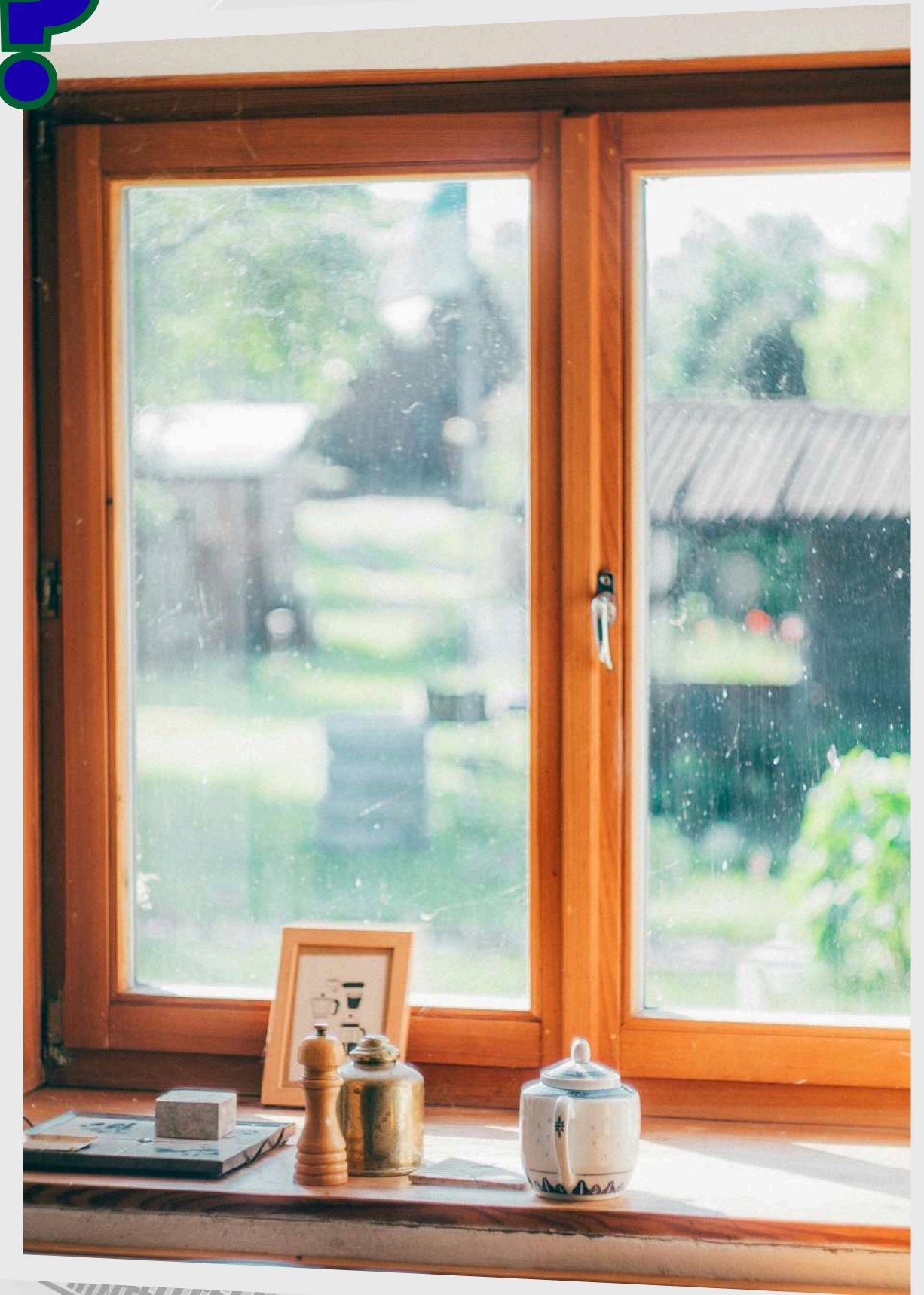

# TYPES OF DOOR & WINDOWS

# SLIDING SYSTEM

C

# SLIDING SYSTEM

## SLIDE & FOLD

## 2 TRACK SLIDING

## 3 TRACK SLIDING



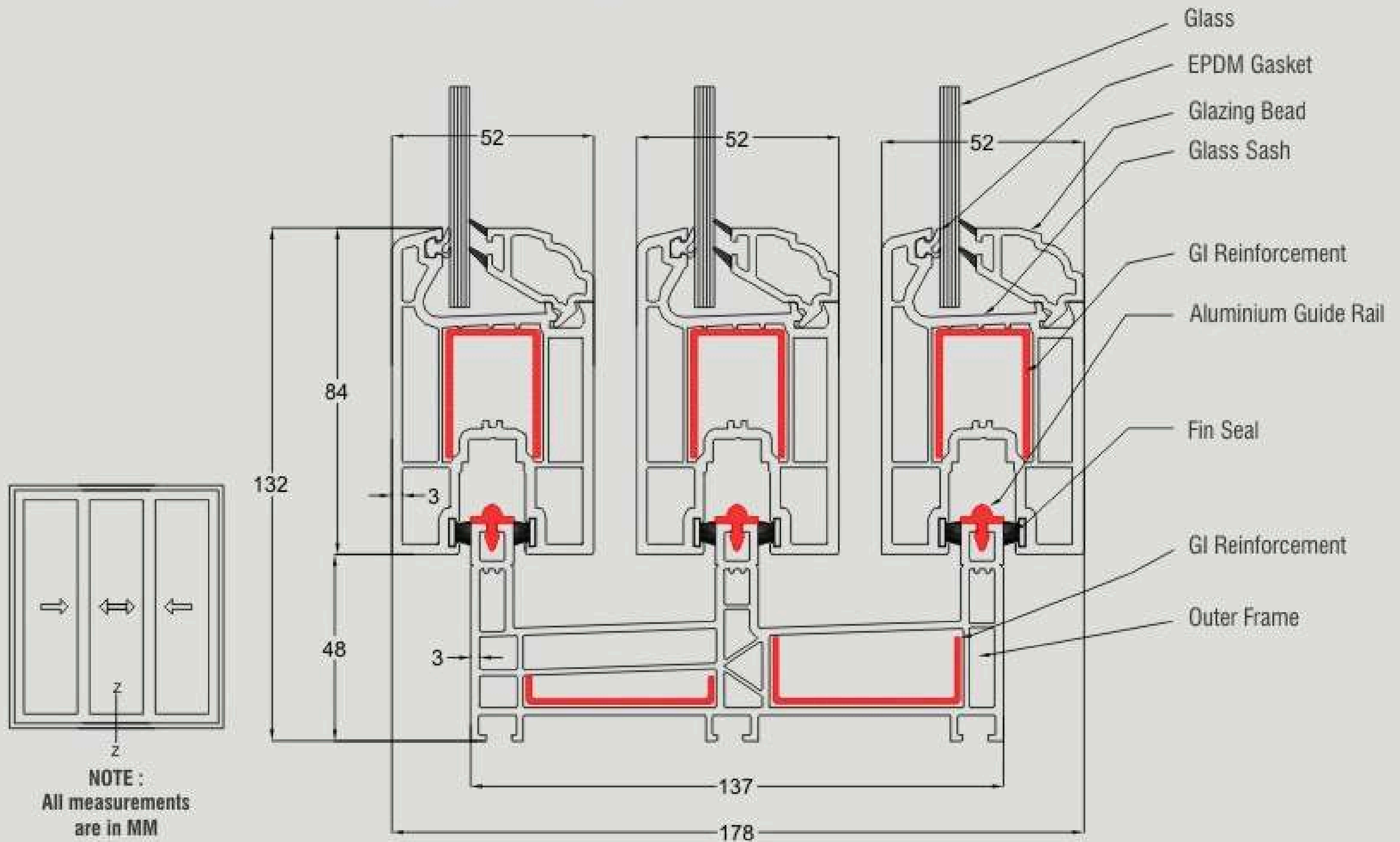

**Cross Section of Sliding Door (3track 3panel) Without Mesh**

# **CASEMENT SYSTEM**

# CASEMENT SYSTEM

TOP HUNG



CASEMENT DOOR



FRENCH DOOR



TILT & TURN

**COMBINATION OF**  
**DOOR & WINDOWS**



# CROSS SECTION OF CASEMENT

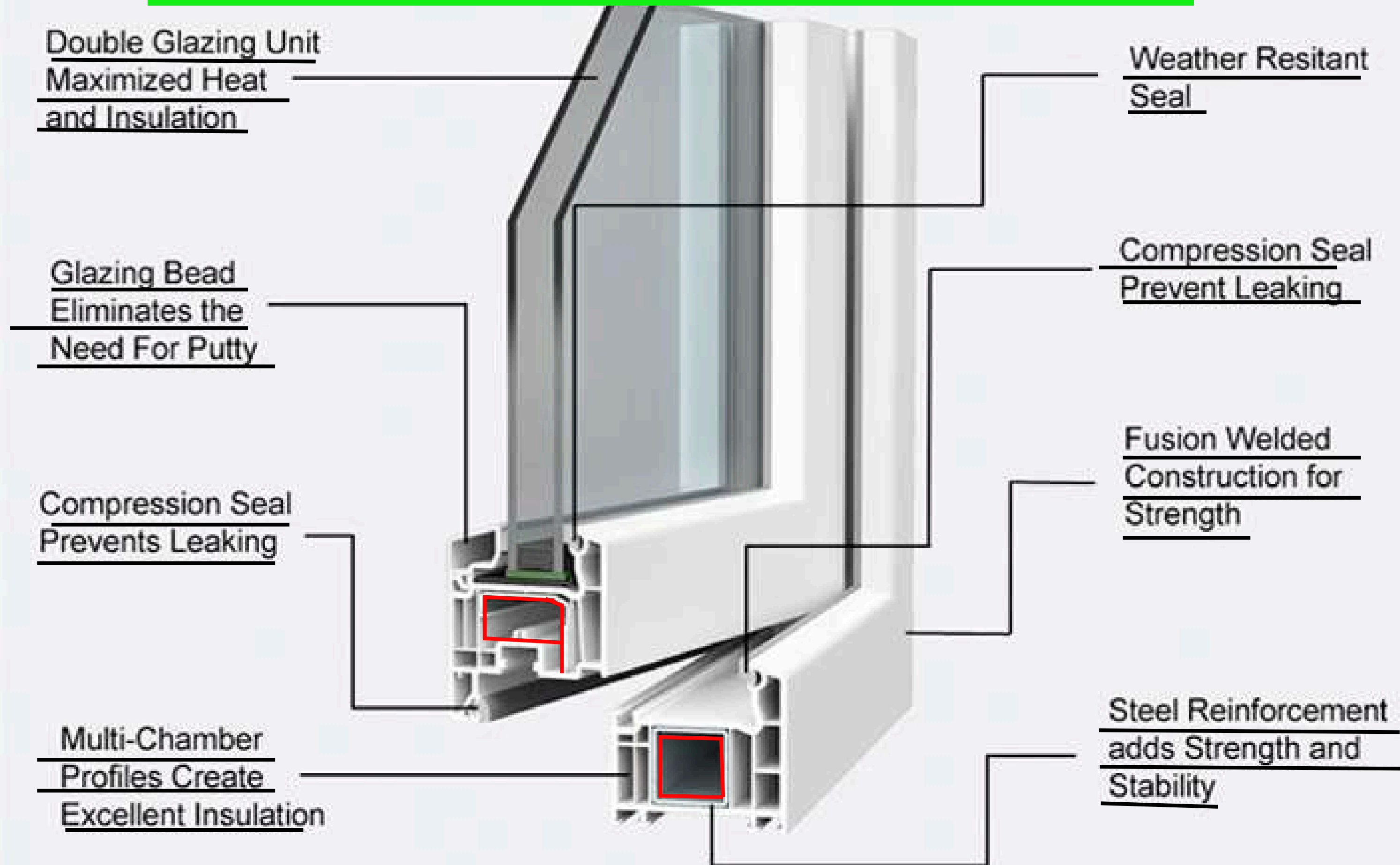

# WOODEN SHADES

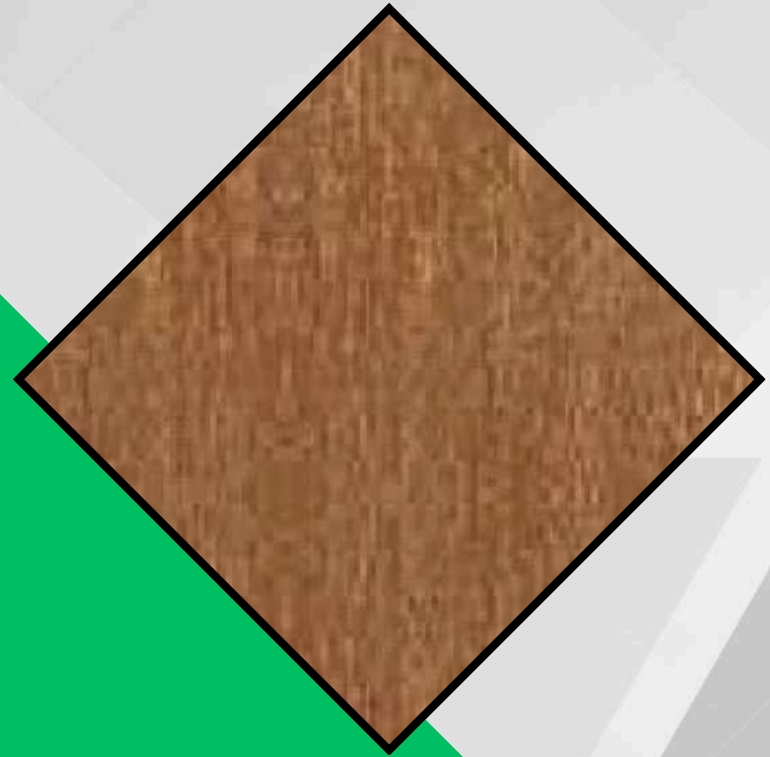

WALNUT



DARK OAK



MAHOGONY

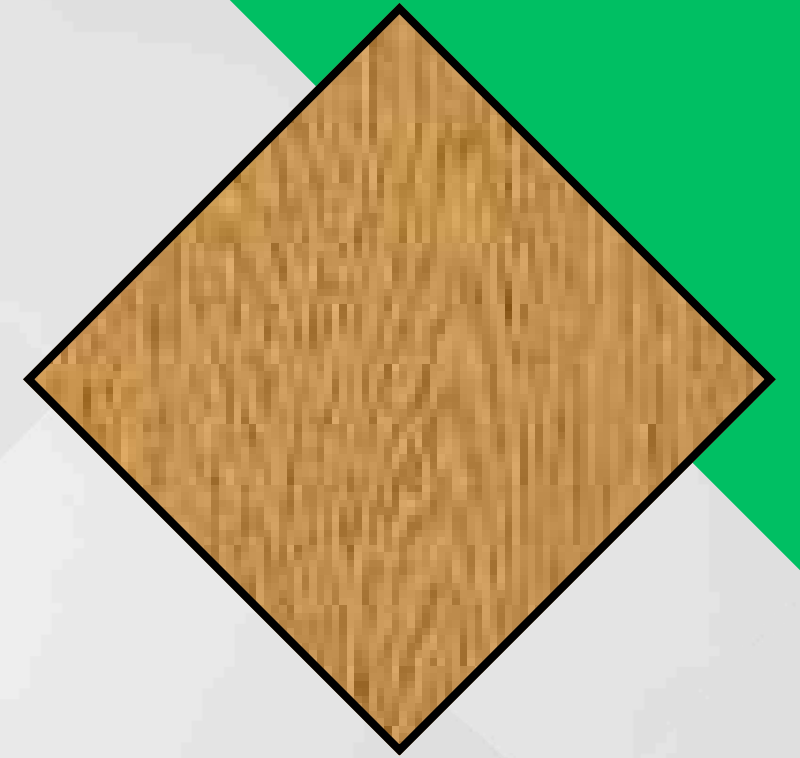

GOLDEN OAK

# COLORS:

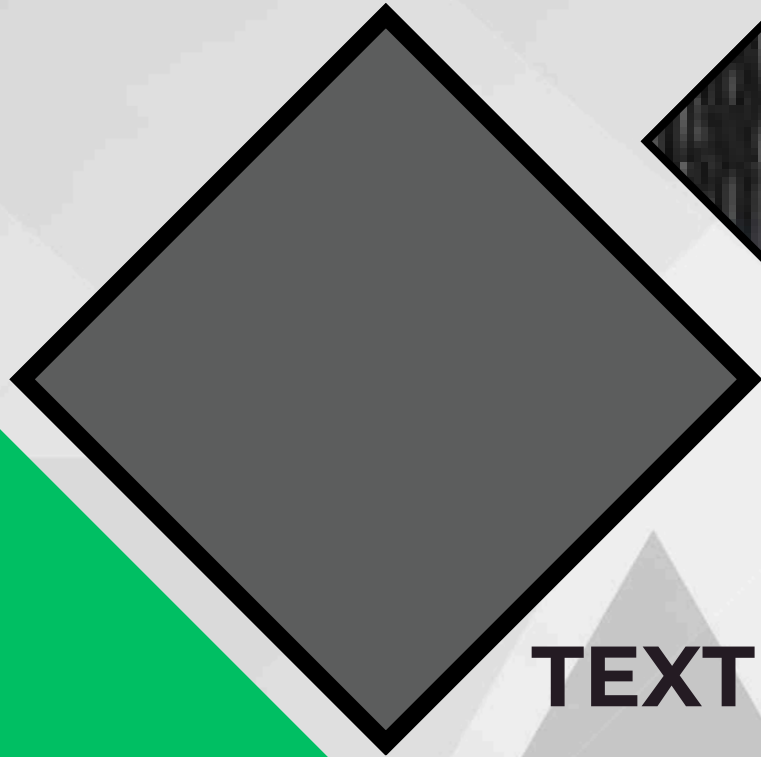

**GREY**

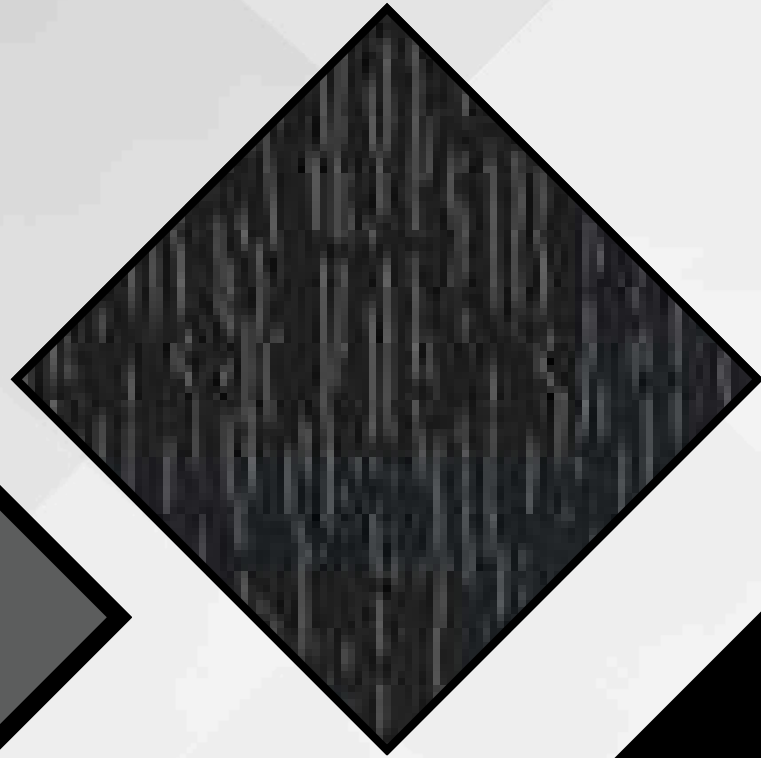

**TEXTURE GREY**



**TEXTURE BLACK**

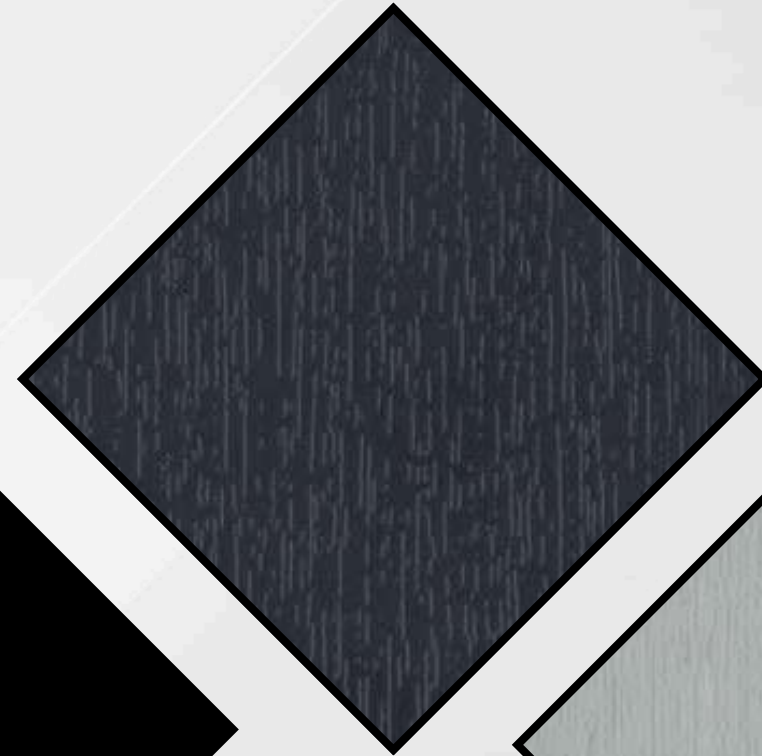

**BLACK**

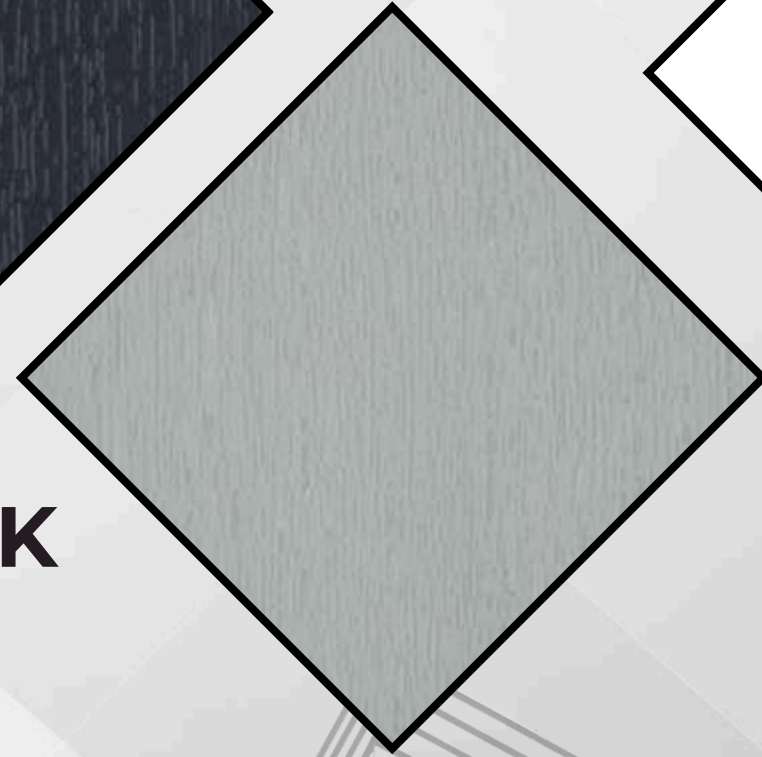

**SILVER GREY**

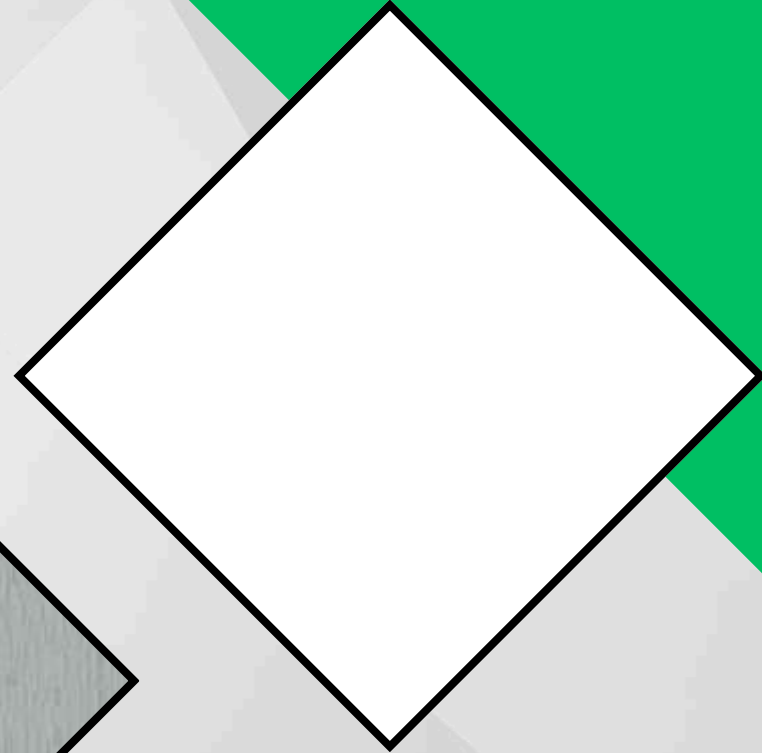

**WHITE**

# Advantages of uPVC DOOR & WINDOWS

## ✓ 1. High Durability

- uPVC does not rot, warp, or corrode.
- Resistant to moisture, sunlight, and harsh weather.
- Long lifespan with minimal wear and tear

## ✓ 2. Low Maintenance

- No painting or polishing required.
- Just simple cleaning with soap and water.
- Hardware lasts longer due to rust-free material.

## ✓ 3. Excellent Insulation

- Provides thermal insulation, keeps rooms cooler in summer and warmer in winter.
- Offers sound insulation, reducing outside noise significantly.

## ✓ 4. Eco-Friendly

- 100% recyclable material. 
- Helps reduce deforestation by avoiding wood usage.

## ✓ 5. Weather & Termite Proof

- Completely rust-proof, termite-proof, and UV-resistant.
- Maintains shape and strength even in extreme climates. 

## ✓ 6. Aesthetic & Customizable

- Available in various colors, designs, glass options, and styles.
- Enhances the modern look of your home or office

# WHY CHOOSE uPVC DOOR & WINDOWS

- ✓ 1. Energy savings from insulation
- ✓ 2. • Modern look and smooth finish
- ✓ 3. • Long lifespan (40–50 years)
- ✓ 4. • Best value for money
- ✓ 5. • Enhances property value

# CLIENTELE

The Tribune



THE  
*ZenD*  
LADAKH



*Coca-Cola*



  
HOTEL  
SAMAYA



# CLIENTELE



INDIAN OIL CORP. LTD.

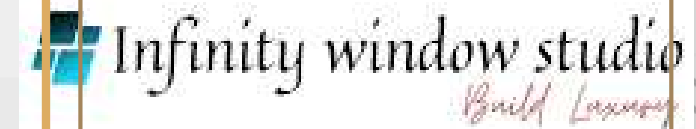

# **GIVES**

- **MG DOOR - MR. GURVINDER SINGH**
- **JEWEL CONCEPT - MR. HARDYAL SINGH**
- **ALP-NISHIKAWA, MR. SANJAY SHAMRA**
- **ANDROMEDA SCIENTIFIC - MR. GAURAV**
- **AR. TARUN DUTT - GARARUN ARCHITECT**
- **MR. AMIT KUMAR KHURANA REAL ESTATE**
- **WOODBARN- MR. SANJAY SHARMA**
- **PREFAB POTA CABIN - MR.GOVIND AHUJA**
- **BLK KASHYAP - MR. SURENDER SINGH**

- **NAIL & HAMMER - MD. AKMAL SAIFI**
- **DEEWAN CONSTRUCTION - MR. SAHIL**
- **AR. CHARU NEXT DIMENTION**
- **AR. SWATI, GURGAON**
- **SOBITE CONTRACTS - MR. SANJAY SOBITE**
- **OM SHIVAM BUILTECH - MR. SACHIN GARG**
- **YUVRAJ CONSTRUCTION - MR. CHANDAN JHA**
- **SANA INFRATECH - MD. SABIR**
- **GARG CONDTRUCTION - MR. AJAY GARG**

# ASK

- **AR. SANJAY ATTRI**
- **FINE AR. ASHOK SHARMA**
- **AR. J. B. SINGH**
- **HAXA DESIGN AR. MANU GUPTA**
- **AR. RITU MAHAJAN**
- **UDA ARCHITECT- MR. MANISH**
- **THE TRADITIONAL ARCHITECT**

- **VASTU VID ARCHITECTS-AR. ARCHIT GUPTA**
- **ARK INFRASTRUCTURE - MR. AJAY KHANNA**
- **SRG ARCHITECH-AR. UDAY BHAN SINGH**
- **GAUTAM & GAUTAM ARCHITECTURE**
- **GOLDEN OAK PROJECTS - MR. RATTAN MANROA**
- **NOVELL CONSTRUCTIONS - MR. HARENDER**
- **NEEV BUILTECH PVT LTD - MR. VIRENDER**

# OUR PROJECTS



LEH LADAKH

# OUR PROJECTS



HOTEL  
SAMAYA



LEH LADAKH

# OUR PROJECTS



LEH LADAKH

# OUR PROJECTS



FARIDABAD

# OUR PROJECTS



FARIDABAD

**PROMINANCE**  
UPVC WINDOW SYSTEMS

# **AUTHORIZED WINDOW PARTNER**

**ALPHA WINDOWS  
FARIDABAD, HARYANA**

Is an authorized partner of  
Prominance uPVC Window Systems.

SF. No. 207/1B & 1C, Selakaraichal Road, Appanaickenpatti  
Sulur, Coimbatore - 641 402. Tamilnadu, India

Tel : +91 4255-265507 | Fax : +91 4255-265505

  
**S. ENIYAN SHIVAM**  
Director

ASTHETIC OUTLOOK | ROBUST SOUL | [WWW.PROMINANCE.COM](http://WWW.PROMINANCE.COM)

**PROMINANCE**  
UPVC WINDOW SYSTEMS

# WARRANTY CERTIFICATE



**ALPHA WINDOWS**  
**FARIDABAD, HARYANA**

This is to certify that our uPVC profiles are warranted for a period of 20 Years against the defect of Discoloration / Color Degradation due to natural weathering of uPVC profiles from the date of Invoice to the customer.

Our uPVC profiles were tested for artificial weathering according to (DIN) EN 513, procedure 2 (simulation of severe climatic zone S) up to a raised irradiation dose of 50 GJ/m<sup>2</sup> with duration of 25,000 hours at world's renowned testing institution in Germany.

SF. No. 207/1B & 1C, Selakaraichal Road, Appanaickenpatti  
Sulur, Coimbatore - 641 402. Tamilnadu, India

Tel : +91 4255-265507 | Fax : +91 4255-265505

  
**S. ENIYAN SHIVAM**  
Director

ASTHETIC OUTLOOK | ROBUST SOUL | [WWW.PROMINANCE.COM](http://WWW.PROMINANCE.COM)



# CONTACT DETAILS

**5H/ 80 NIT FARIDABAD 121001**

**[WWW.ALPHAWINDOW.IN](http://WWW.ALPHAWINDOW.IN)**

**PH:- +919717773116**



**THANK  
YOU**